



SERVICE MANUAL

CTF683

FLAT 68 cm CTV

MODEL: CT-M5930S, CT-M6828S, CT-F683

PROBLEM: RF Interference

File: CTM5830 6828 683 rf interf tb.doc

Some units of the first production lot for the models of reference have been supplied with a low quality RF lead from the RF connector in the back panel to the tuner input. Those units may display diagonal interference lines on the picture mainly in VHF bands.



Low quality cable



Good quality cable

Note that the braid of the good quality cable is very tight and totally covers the internal wire.

Instructions

Replaced the faulty RF cable assembly using the part number **40252200111**.

Regards,

Alcides Berta
TEAC Australia Pty Ltd.

MODEL: CT-F683, CT-M6828S, CT-M5930
PROBLEM: I²C Mitsubishi chassis. Service Mode adjustments

File: CT-F683 CT-M6828 5930 RC tb.doc

The following information applies to all Great Wall models using I²C Mitsubishi technology. A special type of remote control is necessary to access Service Mode adjustments, please refer to the figure.

Accessing Service Mode

- 1- Press first button on the left of the **FACTORY ON** row (Button 1). The word **Key** is visible on the screen.
- 2- Press **FACTORY** button (Button 2). The first page of factory adjustments will be displayed.
- 3- Navigate between parameters and different pages using **UP** and **DOWN** buttons. Direct access to frequently used parameters is available from dedicated buttons, for example **EW WIDTH**, **V AMPL**, etc.
- 4- Adjust parameter values using **VALUE+** and **VALUE -**.

Leaving Service Mode

- 1- Press first button on the left of the **FACTORY ON** row (Button 1). The work **Key** is visible on the screen.
- 2- Press **STANDBY** button.
- 3- Turn **POWER** off from the front panel switch for at least 15 seconds.

Note:

The final version of remote control may be slightly different from the one used to prepare this bulletin.

Regards,

Alcides Berta
TEAC Australia Pty Ltd.



MODEL: CT-M6828S CT-F683 CT-M5930S

PROBLEM: Audio noise

File: CT M6828S M5930S F683 noise tb.doc

A humming noise is audible at low volume from the speakers and particularly from the headphone output (when available). The source of this noise is the vertical deflection circuit.

Instructions

- 1- Delete the jumper W286 on the main PCB next to CN111 in the fly-back transformer area.
- 2- Add a cable between the IF shielding can and the heat sink for the audio output IC.

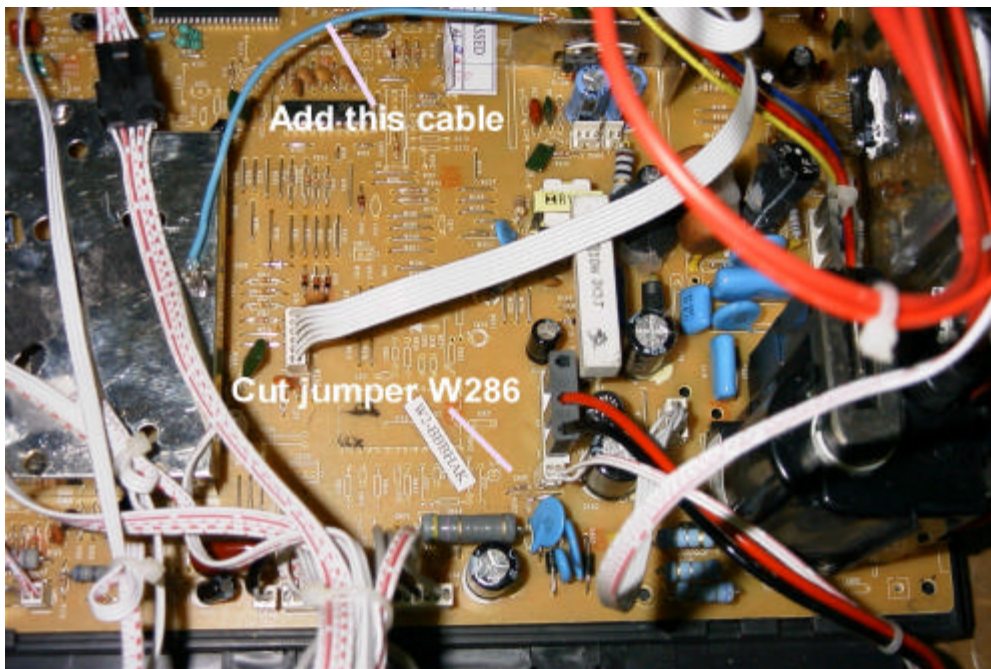

Regards,

Alcides Berta
TEAC Australia Pty Ltd.

MODEL: CT-M6828S, CT-M5930 and CT-F683

PROBLEM: Incorrect resistor type

File: CT-M6828S m oxide.doc

An incorrect resistor type has been fitted in position **R504** of the neck board in some units. A carbon film resistor having a light brown color body and mounted on the surface of the PCB can eventually ignite and burn the board.

Instructions

Replace the carbon film resistor in location **R504** with a metal oxide type. Separate the new resistor from the surface of the PCB by approximately 10 mm.

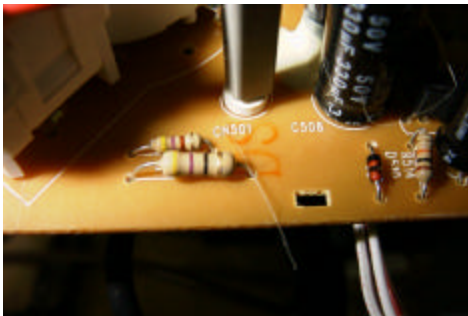

Wrong type
Carbon film resistor
PN: 11347020512
47 Ohm, ½ W



Correct type
Metal oxide resistor
PN: 11347020575
47 Ohm, ½ W

Alcides Berta
TEAC Australia Pty Ltd.

SPECIFICATION

SUPPLY VOLTAGE : AC220V 50Hz $\geq + 10\%$ / -20%

SYSTEM :	PAL - I / I	PAL - BG	PAL - I (UK)	PAL - SECAM - BG / DK	PAL - SECAM - BG / DK (HYPER)	PAL - BG (HYPER)	PAL - BG (CATV)	SECAM - L	L'	
CHANNEL L - VHF : H - VHF : UHF :	4 - 13 21 - 69	2 - 4 5 - 12 21 - 69	21 - 69	1 - 5 6 - 12 21 - 69	1 - 5 6 - 12 21 - 69	E2 - S10 E5 - S41 E21 - E69	E2 - S2 E5 - S20 E21 - E69	1 - Q 21 - 69	FB - FC	CH CH CH
VIF FREQUENCY :	38.9	38.9	39.5	38.0	38.9	38.9	38.9	38.9	32.7	MHz
SIF FREQUENCY :	32.9	33.4	33.5	31.5 32.5	32.4 33.4	33.4	33.4	32.4	39.2	MHz
CHROMA IF FREQUENCY :	34.47	34.47	35.07	33.57 33.57	34.47 34.47	34.47	34.47	34.47		MHz
INTER-CARRIER FREQUENCY :	6.0	5.5	6	6.5 5.5	5.5 6.5	5.5	5.5	6.5	6.5	MHz
SCANNING HORIZONTAL : VERTICAL :	15625 LINE 50 Hz									
ANTENNA INPUT IMPEDANCE :	75 OHM									
CRT :	25" 28" 29" 34"									

ITEMS OF MEASUREMENT	STANDARD		UNIT
	34"	38"	
VIDEO SENS. AT S/N 30db L - VHF H - VHF UHF	≤ 57		dbuv
	≤ 57		dbuv
	≤ 60		dbuv
SOUND SENS. AT S/N 30db L - VHF H - VHF UHF	≤ 42		dbuv
	≤ 42		dbuv
	≤ 48		dbuv
AGC CHARACTER	≥ 60		db
SELECTIVITY -1.5 MHz + 8 MHz	≥ 35		db
	≥ 40		db
COLOR SENS.	≤ 45		dbuv
COLOR LOCK - IN RANGE	≥ ±300		Hz
VERTICAL LOCK - IN RANGE	≥ 6		Hz
HORIZONTAL LOCK - IN RANGE	≥ 400		Hz
MAX BRIGHTNESS	≥ 100	≥ 70 ≥ 65	cd/m ²
MAX OUTPUT POWER	≥ 4.5	≥ 6.0	W
OUTPUT POWER AT 10% THD	≥ 3.5	≥ 4.5	W
BUZZ	≤ -40		db
AFC RANGE	≥ +1		MHz
	≥ -0.5		MHz
MIN. VOL HUM	≤ 20		mV
RESOLUTION HORIZONTAL VERTICAL	≥ 300		LINES
	≥ 400		LINES
LINEARITY DISTORTION VERTICAL HORIZONTAL	≤ 10		%
	≤ 10		%
RASTER DISTORTION	≤ 5		%
REMOTE CONTROL DISTANCE ANGLE	≥ 5		METER
	≥ ±15		DEGREE
POWER CONSUMPTION (AT NORMAL CONDITION)	≤ 120	≤ 150	WATTS
POWER CONSUMPTION (AT MAX. CONDITION)	≤ 150	≤ 180	WATTS
CONVERGENCE DISLOCATION AT AREA "A" AREA "B" (see fig.1)	≤ 0.4		%
	≤ 0.8		%

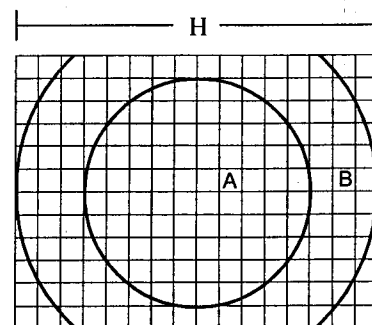

Fig.1

VIDEO INPUT LEVEL : 1.0V P-P ± 3dB
AUDIO INPUT LEVEL : 0.5V RMS ± 3dB

ALIGNMENT INSTRUCTION

I. PLEASE READ BEFORE ATTEMPTING SERVICE

1. Never disconnect any leads while receiver is in operation.
2. Disconnect all power before attempting any repairs.
3. Do not short any portion of the circuit while power is on.
4. For safety reasons, all parts replaced should be identical, (for parts and part numbers see parts list).
5. Before alignment the set must be pre-heated for 30 minutes or more and erase magnetism thoroughly from CRT front chassis frame by erase coil. (Except IF, SYNC, COLOR, SECAM, B+, SOUND)

II. TEST EQUIPMENT

- | | |
|---|---|
| 1. VIF Sweep Generator | 7. Volt Ohmmeter |
| 2. SIF Sweep Generator | 8. High Voltage Meter |
| 3. Colour Bar, Dot, Cross Hatch Generator | 9. Ampere Meter (0.5 Class, DC 3mA Max) |
| 4. DC Power Supply | 10. Demagnetizing Coil |
| 5. Oscilloscope | 11. Philips Pattern Generator |
| 6. Vacuum Tube Voltmeter | 12. High Pot Tester |

III. VIF ALIGNMENT

A. Preparation step. (see fig.2a)

1. Connect Sweep Generator to tuner test point and Ground.
2. Connect 14V \pm 1V Bias Voltage to C429 (+) and Ground, CN904 PIN3 (PIN4 or CN905) and Ground.
3. Connect A. G. C. Bias Voltage to IC201 PIN48 and Ground.
*A.G.C. Bias Voltage can't over 5V. (see fig.2b)
4. Disconnect the soldering pads 'H'.

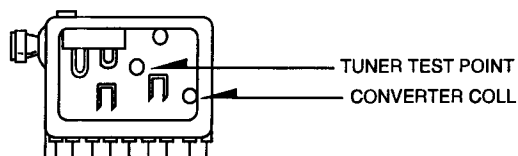
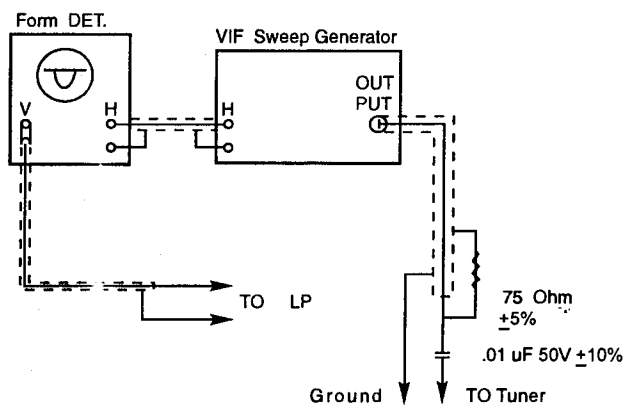

Fig. 2a

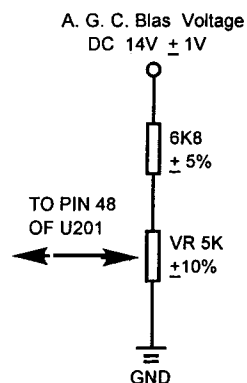

Fig. 2b

B. Alignment Step

1. Calibrate the division of Sweep Generator equal to 100mV per div.
2. The output of Sweep Generator should be $-50\text{dB} \pm 10\text{dB}$.
3. Connect the Waveform Detector to Pin7 of IC201 and Ground.
4. Connect 100ohm ($\pm 5\%$) resistor between Q206 PINB and IC201 PIN10 (only for secam L/L' version).
5. Adjust A.G.C. Bias to maintain the waveform achieve 1V p-p $\pm 10\%$.
6. Adjust T204 to obtain maximum amplitude of response cause at PC (BG = 38.9MHz, I = 39.5MHz, BG / DK = 38.0MHz).
7. Connect 100ohm ($\pm 5\%$) resistor between TP201 and TP202.
8. Adjust tuner converter coil to obtain waveform as Fig.3.
9. Soldering the pads 'H' and disconnect the 100ohm resistors.

REMARK: No need to proceed step 7 and 8, when using Samsung or Telefunken Tuner.
Point (C.C) and point (P.C) have $\pm 0.5\text{div}$ tolerance.

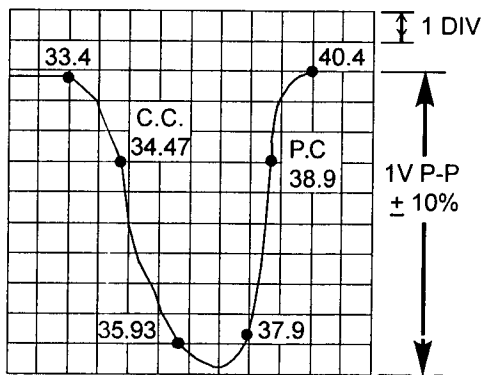

Fig.3

SYSTEM : PAL - BG
PAL - BG / DK
(W / HYPER BAND)

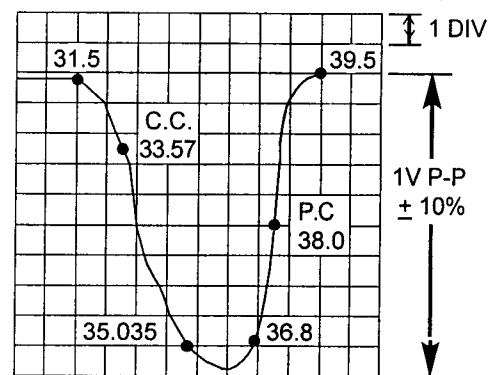

Fig.3

SYSTEM : PAL - BG / DK
(W / O HYPER BAND)

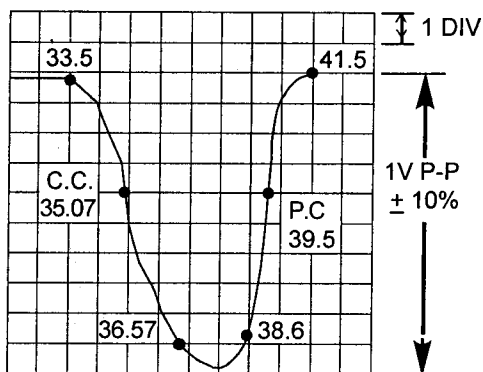

Fig.3

SYSTEM : PAL - I

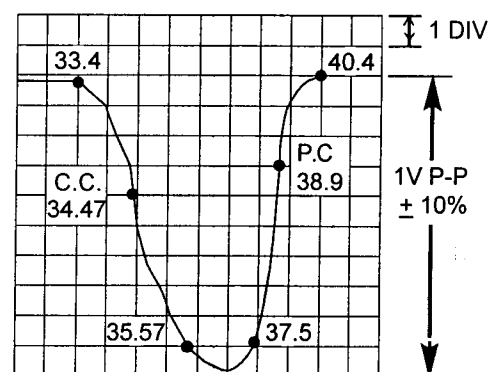
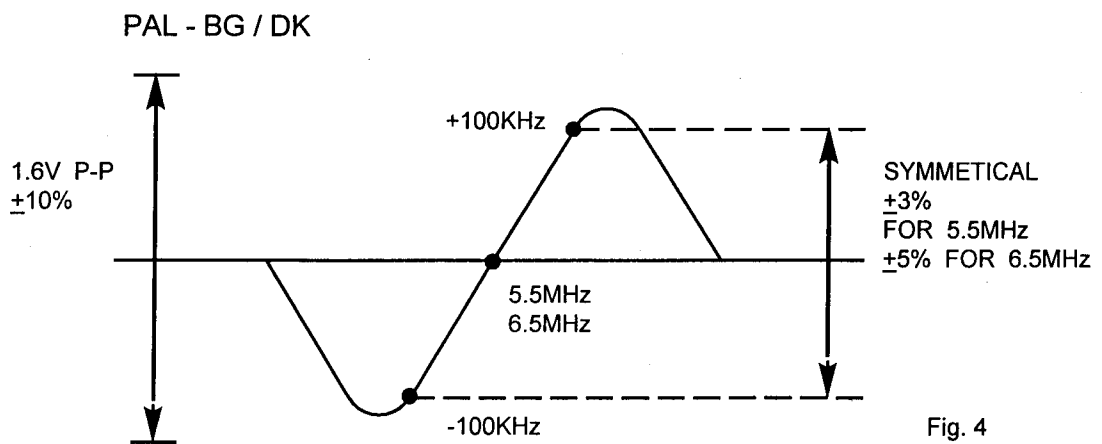
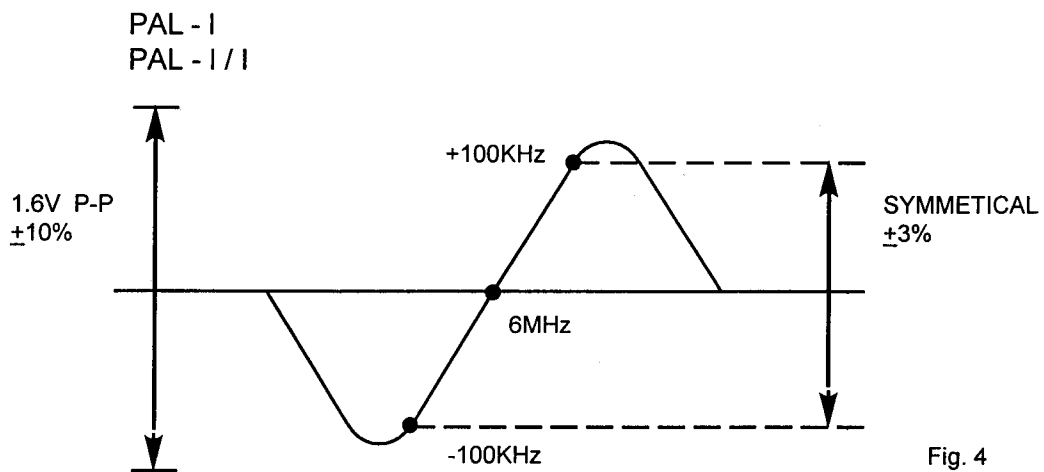
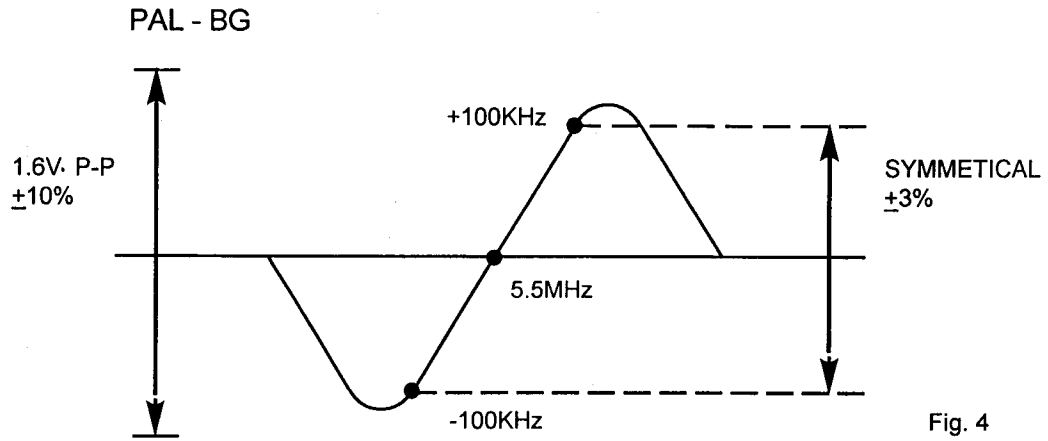

Fig.3

SYSTEM : PAL - I / I

IV. SIF ALIGNMENT

1. Connect the Sweep Generator to IC208 Pin17 and Ground.
2. Connect Waveform Detector to Pin9 of IC208 and Ground.
3. The output of Sweep Generator should be -10dB \pm 5dB.
4. Adjust T202 to obtain the waveform as Fig.4.



V. SIF ALIGNMENT (FOR G.STEREO)

1. Connect the Sweep Generator to IC208 Pin17 and Ground.
2. Connect Waveform Detector to Pin8 of IC208 and Ground.
3. The output of Sweep Generator should be $-10\text{dB} \pm 5\text{dB}$.
4. Adjust T203 to obtain the waveform as Fig.5.
(If haven't Waveform. Set the TACT - SWITCH S609 to SYS - 1 position)

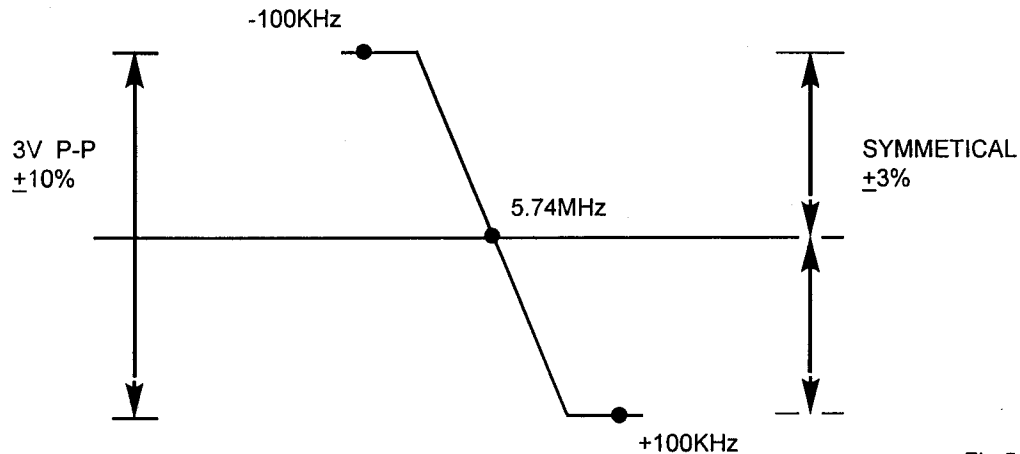

Fig.5

VI. AFC ALIGNMENT

1. Apply Pal IF signal modulated with a colour bar pattern to Tuner IF out and Ground.
(Field strength = $80 \pm 3\text{dB}$)
2. Connect digital voltmeter to Pin44 of IC201 and Ground.
3. Adjust T204 to obtain a reading of $3.75\text{V} \pm 0.25\text{V}$.

VII. SOUND TRACKING ALIGNMENT

1. Receive a gray scale pattern.
2. Connect a oscilloscope and monitor IC208 Pin17 and Ground.
3. Adjust T201 to obtain the waveform Fig.6.

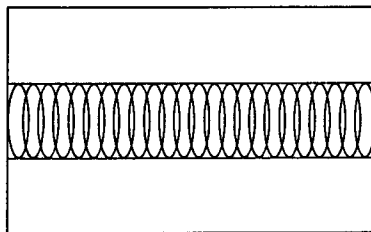

Fig.6

Remark: All frequency of Marker points are $\pm 0.2\%$ tolerance.

VIII. SEPARATION ALIGNMENT (FOR G.STEREO)

1. Receive color bar pattern (with stereo sound L 3KHz, R 1KHz)
2. Connect digital multimeter to PIN1 at CN302 and GND.
3. Adjust volume control to obtain a 0.89Vrms .
4. Switch off the left channel signal (3KHz) from the Signal Generator.
5. Adjust VR001 to make a minimum output level.

B+ ADJUSTMENT

1. Connect a digital voltmeter to B+ and Ground.
2. Set Brightness, Contrast and colour to minimum.
3. Adjust Screen Volume on FBT and VR101 until the picture can just be seen.
4. Adjust VR901 and obtain a reading of 140V \pm 1V. (143V For 28" THOMSON CRT)
(143V For 34" VIDEO COLOR CRT)

AGC ALIGNMENT

1. Receive CH69 (UHF) and input field strength. (see Fig.7).
2. Connect a digital voltmeter between the TUNER AGC TERMINAL and Ground.
3. Adjust the AGC variable resistor (VR201) to maximum position, and then adjust the VR until the AGC voltage drop down 0.4V.
(1/ The drop down voltage should be more than and tends to 0.4V)
(2/ No observable noise can be seen)

TUNER MODEL NO.	RF INPUT SIGNAL(dB)	TUNER MODEL NO.	RF INPUT SIGNAL(dB)
ENV598B7F2	62 \pm 3dB	OSCAR 2900KKC	58 \pm 3dB
UVC6201-RC	57 \pm 3dB	HBC3300KHC	58 \pm 3dB
UVC8303-RW	57 \pm 3dB	TBD1CAB14	60 \pm 3dB
UVL1812-AW	57 \pm 3dB	TECC1986VA0618	60 \pm 3dB
UVC1401-EW	57 \pm 3dB	TBD1-HYPV15A	60 \pm 3dB
TBQ-5-32	57 \pm 3dB	UVE50-AW04D	60 \pm 3dB
TBQ 8-32	57 \pm 3dB	UVE33-W24/R16-3649	58 \pm 3dB
TBQ 8-12	57 \pm 3dB	MTM4045N	57 \pm 3dB
VISHZUZ51	60 \pm 3dB	MTM4045	60 \pm 3dB
TEKE4-196	60 \pm 3dB		
TDQ-3V71(541)	57 \pm 3dB		
UVC1043-RW	57 \pm 3dB(用在1-CHIP)		
	60 \pm 3dB(用在PHILIPS)		

HORIZONTAL CIRCUIT ADJUSTMENT

Fig.7

1. Receive Monoscope Pattern input signal 70dB \pm 10dB.
2. Adjust VR202 to obtain the picture at center \pm 2mm.
(Specification show in Fig.8)

VERTICAL CIRCUIT ADJUSTMENT

1. Receive the Monoscope Pattern.
2. Adjust VR401 to obtain a normal picture.

WHITE BALANCE ALIGNMENT STEP

(Degauss the picture by degaussing coil if necessary)

1. Turn the Brightness, Contrast and Screen Volume to minimum value.
2. Turn VR603 to middle position. Turn VR601, 602, 604, and 605 to middle position.
3. Receive a black and white pattern.
4. Connect a digital meter between Red Gun and Ground on the CRT Board.
5. Adjust VR101 to obtain a ceufre voltage 1.5V \pm 0.1V.
6. Adjust Screen volume on FBT until the brightness bar can just be seen.
7. Adjust VR601, 602, 604 and 605 to obtain a uniform white picture (9300 K +27M.P.C.D) (X = 0.281, Y = 0.311).

SUB - BRIGHTNESS ALIGNMENT

1. Receive a colour bar pattern.
2. Turn the brightness, contrast and colour to minimum.
3. Adjust VR101 until the brightness bar can just be seen.

FOCUS ALIGNMENT

- 1) Set the Brightness and Contrast to middle position.
- 2) Receive a monoscope pattern.
- 3) Adjust focus control to obtain sharpest picture.

EAST - WEST CORRECTION ADJUSTMENT

- 1) Receive a crosshatch and centre cross pattern.
- 2) Turn the Brightness, Contrast to middle position.
- 3) Adjust VR402 to get normal regular picture.
- 4) Adjust VR403 to get a proper horizontal width. (90% +2%)

NTSC EAST WEST CORRECT ADJUSTMENT

- 1) Receive crosshatch pattern and center cross pattern, input signal.
- 2) Turn the brightness, contrast to middle position.
- 3) Adjust VR404 to get a normal regular picture.

HIGH POT TESTING

- 1) Short the L - pole and N - pole of AC line cord.
- 2) Switch on the power switch of the TV Set.
- 3) Connect The High Pot Tester (-) to L and N pole, (+) to the METAL PART of CABINET.

SAFETY STD. / CONDITION	TEST SYANDARD	TEST STANDARN FOR PRODUCTION
VDE, SAA	3.0KV 10mA / 1MIN	≥ 3.5 KV ≤ 10 mA / ≥ 10 SEC.
BS	4.0KV 10mA / 1MIN	≥ 4.0 KV ≤ 10 mA / ≥ 10 SEC.
CHINA STANDARD	3.0KV 10mA / 1MIN	≥ 3.3 KV ≤ 5 mA / ≥ 6 SEC.
UL	1.0KV 5mA / 1MIN	≥ 1.25 KV ≤ 5 mA / ≥ 1 SEC.

Remark:

- 1) If no other specify, the strength of input signal should be 70dB ± 10 dB.
- 2) The High Pot Tester can have $\leq \pm 5\%$ tolerance.

DISTRICT	CENTRE (mm) POSITION	LIMIT (mm)	SCANNING SIZE (%)	SCANNING SIZE LIMIT (%)
THAILAND	-1	0 ~ -2	90	88 ~ 92
FRANCE	+3	0 ~ +5	90	88 ~ 94
GERMANY	+3	0 ~ +5	90	90 ~ 95
*GROUP A	-2	-5 ~ -1	90	88 ~ 94
*GROUP B	0	-2 ~ +2	90	88 ~ 94
*GROUP C	+3	0 ~ +5	90	88 ~ 94

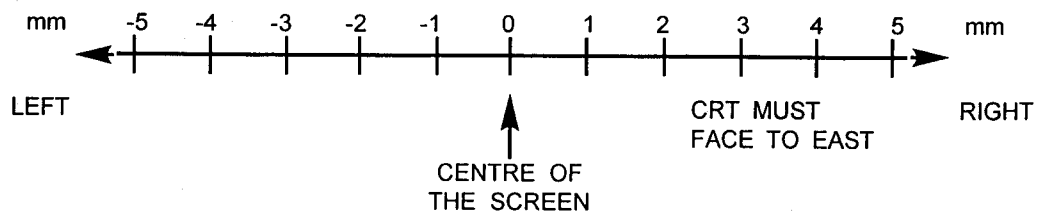

FIG. 8

- REMARK :
1. SUITABLE FOR 14" OR ABOVE TV.
 2. Adjust the centre position must take the upper side of monoscope pattern for standard.
 3. Group A : AUSTRALIA, NEW ZEALAND, TAHITI.
 4. Group B : HONG KONG, CHINA, AMERICA, CANADA, MALAYSIA, MEXICO.
 5. Group C : ENGLAND, ITALY, GERMANY, RUSSIA, SWITZERLAND, JUGOSLAVIA, SPANISH.
- If the above countries are not include, please consult to Engineering Dept.

VOLTAGE TABLE FOR IC (ONLY FOR REFERENCES)						
SYMBOL PIN NO.	IC 201 TDA 8362	IC 101 CTV 350	IC001 SAA7282ZP	IC208 TDA3866	IC002 TDA8732	IC103 PC74HCT241P
1	3	4.3	2.5	0	0.3	0.085
2	5.8	0.1	5.1	0	GND	0.010
3	5.8	4.7	5	2.3	2.2	0.012
4	5.5	2.4	5	0.1	5.3	0.010
5	0	4.9	5	3	4	0.011
6	3.8	2.5	5.1	1.8	4.1	0.012
7	3	0	4.9	1.8	4.1	0.012
8	1.7	4.5	4.7	2.1	3.9	0.012
9	GND	1.6	GND	2.1	3	0.012
10	7.8	5	2.3	1.8	2.2	0.012
11	GND	0	2.3	1.8	4.4	0.085
12	3.1	5.6	2.3	5.7	5.3	0.012
13	4.3	5	2.3	5.7	4.5	0.12
14	3.3	5	2.3	1.9	GND	0.089
15	3.4	5	2.3	0	1.1	0.012
16	0	5	2.3	2.1	2.5	0.09
17	4.2	5	2.3	2.1	0.2	0.012
18	2.8	0.1	GND	1.8	4.6	0.095
19	2.8	5	2.3	0	GND	0.012
20	0	5	2.4	GND	3.3	0.085
21	0.3	0	2.3	6.7		
22	3.4	0	0.4	4.3		
23	3.4	0	2.3	1.7		
24	3.4	0	GND	1.7		
25	2.6	0	4.9			
26	1.7	0.3	4.9			
27	2.4	-0.3	5			
28	3.9	5	2.5			
29	3.8	5	GND			
30	1.4	0	2.1			
31	1.4	2.6	1.6			
32	1.6	2.1	1			
33	5.1	5				
34	1.3	5.4				
35	2	4.8				
36	7.7	0				
37	0.5	0				
38	0.6	0				
39	2.4	3				
40	3.7	2.7				
41	2.3	0				
42	2.8	5				
43	5					
44	3.9					
45	4					
46	4					
47	8.1					
48	4.5					
49	0.8					
50	3.3					
51	4.3					
52	6.5					

SYMBOL PIN NO.	IC403	IC404	IC102
1	16.03	11.9	11
2	0	0	0
3	11.9	7.9	5

IC601 TDA6103Q	
1	1.144V
2	1.144V
3	1.144V
4	0V
5	1.144V
6	205V
7	99V
8	99V
9	99V

NOTE: VOLTAGE ARE TAKEN UNDER TUNED CONDITION WITH

CONTRAST : Maximum Position
 BRIGHTNESS : Maximum Position
 COLOR : Maximum Position
 SIGNAL INPUT : 70dB ±10dB
 CHANNEL SETTING : The Last Channel of UHF High
 SIGNAL PATTERN : Colour Bar

VOLTAGE TABLE FOR TRANSISTOR (ONLY FOR REFERENCE)				VOLTAGE TABLE FOR IC				
SYMBOL	B (V)	C (V)	E (V)	SYMBOL PIN NO.	IC402 HEF4538BP	IC204 TDA8395	IC205 TDA4661	IC203 TDA8440
Q108	11.7	0	11.8	1	0	4.4	5.2	2.7
Q107	11	11.7	11.8	2	4.9	1.3	0	GND
Q111	9.9	11.8	10.6	3	11.9	7.9	0	2.8
Q112	2.7	11.1	10.6	4	1	0	0	GND
Q113	0.2	2.7	0	5	11.9	0	1.4	5.6
Q101	0.7	1.5	0	6	11.5	0	0	11.9
Q104	0	11.7	0	7	0.3	3.3	0	5.6
Q105	0.6	0	0	8	GND	4.2	0	5.6
Q103	0.02	4.6	0.02	9	0	3	5.2	5.6
Q208	3.3	8	2.7	10	11.9	3	0	5.6
Q201	2.3	11.6	1.7	11	11.9	0	2.9	11.9
Q206	8.5	3	8	12	0.3	0	2.9	5.7
Q205	2.1	7.8	1.5	13	11.9	0	0	11.9
Q204	3	7.4	2.3	14	3.4	0	1.3	5.7
Q117	5	0	0	15	0	1.2	0	11.9
Q116	0.6	0	0	16	11.9	0.6	1.3	2.5
Q002	2	3	1.3	17				0
Q001	2	5.3	2.6	18				0
Q003	0.3	11.8	0					
Q118	0.6	0	0					
Q331	2.3	5.3	1.7					
Q332	2.3	5.3	1.7					
Q401	0.4	38.2	0					
Q114	0.7	2.7	0					
Q404	11.2	0.5	11.7					
Q405	0.5	14.2	0					
Q410	2	10.1	1.4					
Q406	0	2	1.6					
Q402	0	113.6	0					
Q106	11.5	0.4	11.8					
Q151	0.02	10.6	0					
Q601	3.1	118.3	2.5					
Q602	3	119.7	2.5					
Q603	3.2	113	2.6					
Q604	3.7	0	4.1					
Q605	0	173.8	0.15					
Q606	0.1	11.2	0					

SYMBOL PIN NO.	IC401 TDA3654	IC202 TA7347P	IC104 24C01B2	IC901 ST6309
1	1.1	8.3	0	0.7
2	0	GND	5	0.2
3	1.2	8.3	0	0.1
4	0	GND	0	0.3
5	15.6	0	2.6	0.7
6	25.6	7.5	3	0.1
7	1.2	11.9	5	0.2
8	5.8		5	0.5
9	25.4			10

SYMBOL PIN NO.	IC102 L7805	IC403 L7812	IC404 L7808
1	10	14	12
2	GND	GND	GND
3	5	12	8

NOTE : VOLTAGE ARE TAKEN UNDER TUNED CONDITION WITH

CONTRAST : Maximum Position
 BRIGHTNESS : Maximum Position
 COLOR : Maximum Position
 SIGNAL INPUT : 70dB \pm 10dB
 CHANNEL SETTING : The Last Channel of UHF High
 SIGNAL PATTERN : Colour Bar

VOLTAGE TABLE FOR TRANSISTOR (ONLY FOR REFERENCE)								
LOCATION \ TR	B (V)	C (V)	E (V)	LOCATION \ TR	B (V)	C (V)	E (V)	
Q108	11.7	0	11.8	Q332	2.3	5.3	1.7	
Q107	11	11.7	11.8	Q401	0.4	38.2	0	
Q111	9.9	11.8	10.6	Q114	0.7	2.7	0	
Q112	2.7	11.1	10.6	Q404	11.2	0.5	11.7	
Q113	0.2	2.7	0	Q405	0.5	14.2	0	
Q101	0.7	1.5	0	Q410	2	10.1	1.4	
Q104	0	11.7	0	Q406	0	2	1.6	
Q105	0.6	0	0	Q402	0	113.6	0	
Q103	0.02	4.6	0.02	Q106	11.5	0.4	11.8	
Q208	3.3	8	2.7	Q151	0.02	10.6	0	
Q201	2.3	11.6	1.7	Q601	3.1	118.3	2.5	
Q206	8.5	3	8	Q602	3	119.7	2.5	
Q205	2.1	7.8	1.5	Q603	3.2	113	2.6	
Q204	3	7.4	2.3	Q604	3.7	0	4.1	
Q117	5	0	0	Q605	0	173.8	0.15	
Q116	0.6	0	0	Q606	0.1	11.2	0	
Q002	2	3	1.3					
Q001	2	5.3	2.6					
Q003	0.3	11.8	0					
Q118	0.6	0	0					
Q331	2.3	5.3	1.7					

NOTE : VOLTAGE ARE TAKEN UNDER TUNED CONDITION WITH

CONTRAST : Maximum Position
 BRIGHNESS : Maximum Position
 COLOR : Maximum Position
 SIGNAL INPUT : 70dB \pm 10dB
 CHANNEL SETTING : The Last Channel of UHF High
 SIGNAL PATTERN : Colour Bar

VOLTAGE TABLE FOR IC (ONLY FOR REFERENCES) (FOR TEXT. IC VOLTAGE)						
PIN NO.	SYMBOL	IC 801 SAA5246	IC 801 SAA5254PT	IC 802 GM76C88AL-15		
1		5.1	5.1	0		
2		2.17	2.2	4.38		
3		3.64	3.7	2.5		
4		0.04	0.044	2.2		
5		GND	GND	4.24		
6		5.09	5.1	1.4		
7		2.1	2.2	1.07		
8		2.09	2.4	3.65		
9		2.55	2.56	3.63		
10		5.1	5.1	3.74		
11		GND	GND	0.03		
12		2.18	2.4	0.82		
13		5.1	5.1	2.5		
14		GND	GND	GND		
15		0.28	0.12	1.2		
16		0.2	0.12	1.5		
17		0.28	0.11	1.6		
18		3.92	3.93	1.3		
19		4.85	0.11	1.08		
20		0.048	GND	GND		
21		2.56	0.08	4.32		
22		0.045	0.05	2.55		
23		2.87	0.05	0.85		
24		2.56	3.11	0.87		
25		GND	2.84	0.83		
26		1.2	5.09	5.1		
27		1.62	5.09	5.07		
28		1.7	5.09	5.1		
29		1.5	5.09			
30		1.1	5.09			
31		2.5	5.09			
32		0.8	0.058			
33		0.036	5.09			
34		3.74	5.09			
35		3.63	5.09			
36		3.65	0.057			
37		1.07	5.09			
38		1.4	5.09			
39		4.24	0.056			
40		2.1	0.06			
41		2.5				
42		4.38				
43		4.33				
44		0.8				
45		0.88				
46		0.83				
47		2.55				
48		5.07				
49						
50						

NOTE : VOLTAGE ARE TAKEN UNDER TUNED CONDITION WITH

CONTRAST : Maximum Position
 BRIGHNESS : Maximum Position
 COLOR : Maximum Position
 SIGNAL INPUT : 70dB \pm 10dB
 CHANNEL SETTING : The Last Channel of UHF High
 SIGNAL PATTERN : Colour Bar

PART_NO	DESCRIPTION	QTY	LOCATION
155R833030204	REMOTE CONTROL ASSY (RC-786)	1	
107-800455-4G	RESONATOR 455 KHZ ET455Z PO TUNG	1	CF701
113-109005-17	CARBON FILM RESISTOR 1 OHM 1/16W +-5%	2	R701,703
113-221005-17	CARBON FILM RESISTOR 220 OHM 1/16W +-5%	1	R702
123-151350-93	CERAMIC CAP. 150 PF 50V +-10% (NPO)	2	C701,702
127-105072-06	ELECT CAP. 1 MFD 50V +-20% {TAPING TYPE}	1	C703
130-134148-01	SILICON DIODE IN4148	3	D702-704
130-600101-0G	INFRARED EMITTER EL-1L1 KODENS HI "GUANG ZHO	1	LED701
131-231815-0A	TRANSISTOR 2SC1815 TOSHIBA	1	Q701
133-803428-12	I.C. M34280M1 MITSUBISHI	1	IC701
172-726000-99	BARE WIRE 54MM	0.11	W701
190-R83301-02	REMOTE P.C.B. (270499 REV.1)	1	
514-200407-10	SELF-TAPPING SCREW 2 X 7 B/T (HARDEN)	1	FOR HANDSET
774-002001-00	BATTERY SPRING +VE & -VE	1	
774-R83301-00	BATTERY SPRING (-VE)	1	
774-R83302-00	BATTERY SPRING (+VE)	1	
810-041104-13	POLYBAG 4" X 11" X 0.04MM W/RE-CYCLING MARK	1	FOR HANDSET
849-R83301-08	RUBBER KEY PAD - ENG STD {FOR MTSUBISHI IyC}	1	
900-R83301-46	R/TOP CAB-ENG STD/M.BLK SILVER 877C (FOR MITSU	1	
902-R83301-01	HANDSET REAR CAB - MATT BLK SPARY	1	
910-R83301-01	BATTERY DOOR - MATT BLACK	1	
919-R83310-12	REMOTE TOP DOOR - TEAC DESIGN {CT-F683} (RC-78	1	
504-305006-10	MACHINE SCREW 3 X 6 B/M (WHITE)	2	FOR POWER SWITCH MTG.
509-305010-00	MACHINE SCREW 3 X 10 KM (BLACK)	2	FOR JACK PLATE MTG.
514-300106-10	SELF-TAPPING SCREW 3 X 6 B/T (WHITE)	3	FOR FUNCTION PCB TO F.CAB
514-400312-10	SELF-TAPPING SCREW 4 X 12 B/A (HARDEN)	1	FOR HEAT SINK (A) TO FBT
514-400416-10	SELF-TAPPING SCREW 4 X 16 B/T (HARDEN)	8	8 FOR SPEAKER MTG
514-400425-10	SELF-TAPPING SCREW 4 X 25 B/T (HARDEN)	9	FOR CABINET MTG.
515-303408-10	SELF-TAPPING SCREW 3 X 8 W/B/T (HARDEN)	1	FOR AC LINE CORD
515-303408-10	SELF-TAPPING SCREW 3 X 8 W/B/T (HARDEN)	16	5-TOP PANEL TO F.CAB,9-BELOW COVER TO F.CAB
515-303408-10	SELF-TAPPING SCREW 3 X 8 W/B/T (HARDEN)	0	2-FUNCTION PCB TO F.CAB
515-303410-10	SELF-TAPPING SCREW 3 X 10 W/B/T (HARDEN)	6	6 FOR POWER BOARD
515-303410-10	SELF-TAPPING SCREW 3 X 10 W/B/T (HARDEN)	4	2-POWER SWITCH BKT,2-REMOTE CONTROL BKT
515-303412-10	SELF-TAPPING SCREW 3 X 12 W/B/T (HARDEN)	13	FOR MAIN PCB
516-500418-10	SELF-TAPPING SCREW 5 X 18 P/T (HARDEN) HEAD DI	4	FOR SPK HOLDER MTG
517-306110-10	SELF TAPPING SCREW 3 X 10 W/T W/H =10MM	2	2-SIDE JACK PCB
524-382904-00	CRT MTG.SCREW 6X35 VP (HARDEN)	4	FOR CRT MTG
580-101261-01	CABLE TIE L=100MM	2	FOR POWER SWITCH PCB
618-282901-00	PACKING PAD (550 X 150.0MM)	2	
622-733B01-00	PAD CORD L240 X W10 X TO.5MM W/TAPE	8	FOR BETWEEN - CRT & FRONT CAB
622-882802-00	FELT L240 X W17 X TO.5MM W/TAPE	9	7-F.CAB.,2-SPK.SIDE
631-282901-00	FIBRE COVER (BLACK)	1	FOR B.CAB
777-942702-00	SPRING IN ID11 X L23.5	1	
800-282901-00	POLYFOAM TOP	1	
800-282902-00	POLYFOAM TOP	1	
800-282903-00	POLYFOAM BOTTOM	1	

PART_NO	DESCRIPTION	QTY	LOCATION
800-282904-00	POLYFOAM BOTTOM	1	
810-052204-14	POLYBAG 5" X 22" X 0.04MM W/RE-CYCLING MARK {P/	1	FOR AC LINE CORD
822-733A01-00	SPEAKER HOLDER CUSHION	2	FOR SPK HOLDER TO SPK
826-432005-00	FOAM SHEET - 43" X 20" X 0.5MM THK	1	FOR TOP
834-230802-00	RUBBER WASHER OD=23, ID=8, T=2	4	FOR RCA CRT 1-SPK.SIDE (PEM95065),4
840-011024-21	PAD CORD L240 X W10 X T1 MM W/TAPE	5	FOR SPK HOLDER FOR RCA CRT TO FRONT
840-051030-11	RUBBER PAD (ONE SIDE W/TAPE)	4	CABINET 2 FOR SPK HOLDER TO F.CAB,2 FOR SPK HOLDER
840-082929-11	RUBBER PAD (ONE SIDE W/TAPE)	4	TO CRT
896-882101-00	POWER BOARD COVER (UL)	1	
918-733A01-00	SPEAKER HOLDER COVER BLACK PP	2	
920-282901-U0	P.C.B MTG BRACKET BLACK ABS UL94V0	1	
923-282901-00	POWER SWITCH BKT	1	
939-922002-00	POWER SWITCH ADAPTOR (NTSC)	1	FOR POWER SWITCH
948-882003-00	DOOR LOCKER	1	
954-733A02-00	SPEAKER HOLDER BLACK PP	2	
954-882100-00	AC LINE CORD CLIP	1	
954-882804-00	HIGH VOLTAGE CABLE SPACER	3	FOR FBT
003-131315-0E	TUNER 38.9 MHZ(WSP HYPER BAND) UV1315 PHILIPS	1	TUNER
107-731500-0I	SAW FILTER 31.5 MHZ B5308 "NANYANG"	1	SAW102
107-738916-0I	SAW FILTER 38.9 MHZ B5316 "NANYANG"	1	SAW101
113-101005-17	CARBON FILM RESISTOR 100 OHM 1/16W +-5%	2	R330,331
113-122005-17	CARBON FILM RESISTOR 1.2K OHM 1/16W +-5%	1	R334
113-183005-17	CARBON FILM RESISTOR 18K OHM 1/16W +-5%	1	R336
113-202005-17	CARBON FILM RESISTOR 2K OHM 1/16W +-5%	1	R335
113-220305-75	METAL OXIDE FILM RESISTOR 22 OHM 1W +-5%	1	R337
113-393005-17	CARBON FILM RESISTOR 39K OHM 1/16W +-5%	1	R333
113-821005-17	CARBON FILM RESISTOR 820 OHM 1/16W +-5%	1	R332
123-101350-60	CERAMIC CAP. 100 PF 50V +-10% (SL TYPE) "SMART G	2	C333,334
123-104270-90	CERAMIC CAP. 0.1 MFD 25V +80 -20%	4	C335,336,337,338
123-221350-60	CERAMIC CAP. 220 PF 50V +-10% (SL TYPE)	1	C342
123-271350-60	CERAMIC CAP. 270 PF 50V +-10% (SL TYPE)	2	C330,331
123-331350-60	CERAMIC CAP. 330 PF 50V +-10% (SL TYPE)	1	C332
126-104071-01	MYLAR CAP. 0.1 MFD 50V +-10%	1	C340
126-224071-01	MYLAR CAP 0.22 MFD 50V +-10%	1	C339
127-226042-06	ELECT CAP. 22 MFD 16V +-20% {TAPING TYPE}	1	C341
130-410120-01	ZENER DIODE 12V 1/2W +-5% "TEMIC"	1	ZD330
133-104565-33	I.C. TDA4565 PHILIPS	1	IC330
133-108843-33	I.C. TDA8843 PHILIPS	1	IC101
160-102255-27	PIN CONNECTOR 2 PINS PLUG STRAIGHT (UL) (S.H.S)	0	CN333,335
160-104255-27	PIN CONNECTOR 4 PINS PLUG (SHS)	1	CN334
166-281936-4H	SPEAKER 3" X 6" 8 OHM 10W (YDT 816-3B-SP) "TCL"	2	
186-223500-15	HI-WATT REGULAR STANDARD 2A R6P VINYL JACKET	2	
190-282907-08	SIDE AV IN & EARPHONE BOARD (200100)	1	
190-932900-20	CTI P.C.B. (020200)	1	FROM MAIN PCB CN333 TO
191-201231-10	2 PIN FLAT CABLE L=140MM AWG26 (1 SIDE SOCKET,	1	CTI PCB CN331, PIN '1' TO '1'
191-201231-10	2 PIN FLAT CABLE L=140MM AWG26 (1 SIDE SOCKET,	0	'2' TO '2'

PART_NO	DESCRIPTION	QTY	LOCATION
			FROM MAIN PCB CN335 TO
191-201237-15	2 PIN FLAT CABLE L=200MM (1 SIDE SOCKET, 1 SIDE P	1	CTI PCB CN332, PIN `1'TO`1'
191-201237-15	2 PIN FLAT CABLE L=200MM (1 SIDE SOCKET, 1 SIDE P	0	`2'TO`2'
191-401005-10	4 PIN SOCKET ASS'Y L=450MM	1	FOR CRT
			FROM MAIN PCB CN334 TO
191-401240-10	4 PIN FLAT CABLE 120MM #28 UL 20080 1 SIDE SOCK,	1	CTI PCB CN330, PIN `1'TO`1'
191-401240-10	4 PIN FLAT CABLE 120MM #28 UL 20080 1 SIDE SOCK,	0	`2'TO`2', `3'TO`3', `4'TO`4'
610-382903-02	GIFT BOX - TEAC DESIGN (K3A3A3K) (CT-F683)	1	
663-230904-99	SERIAL NO.LABEL - TEAC DESIGN	4	
669-282901-05	RATING LABEL - TEAC DESIGN (CT-F683) {240V}	1	
670-282900-32	INSTRUCTION MANUAL - TEAC DESIGN (CT-F683) {220	1	
678-183B01-15	TOTAL CARE LABEL - TEAC (C) DESIGN	1	
678-282901-09	SCREEN STICKER - TEAC DESIGN (CT-F683)	1	
690-942039-02	WARRANTY CARD -TEAC (C) DESIGN	1	
693-282901-11	EAN CODE LABEL - 9325073002005	2	
710-932901-01	NAME PLATE - TEAC (B) DESIGN (BIG SIZE) (ELECTRO	1	
762-932003-00	MOUNTING CLIP	1	
810-091504-13	POLYBAG 9" X 15" X 0.04MM W/ RE-CYCLING P.E.MAR	1	FOR I/MANUAL
810-455304-60	POLYBAG 45"X53"X0.04MM (TEAC DESIGN CT-M596SR	1	FOR UNIT
884-282903-03	P/PLATE - ENG STD W/GREY COOL 2C S.S (7 HOLE)	1	
884-282933-02	SIDE JACK COVER - ENG STD W/WHITE S.S 3 KEY	1	
884-729A43-02	JACK COVER - TEAC DESIGN {CT-F683}	1	
900-282901-14	FRONT CABINET - SILVER 1008K SPRAYED	1	
902-282902-U1	REAR CAB. - M.BLK 729B BKT & 729A JACK PLATE W/O	1	
919-282901-17	PRESET DOOR - SILVER (1008K) TEAC DESIGN (CT-F6	1	
930-282901-14	BELOW COVER - SILVER (1008K) W/DARK GREY 433C	1	
931-282901-16	TOP PANEL - SILVER (1008K) SPRAYED	1	
949-282903-12	HANDLE BASE - SILVER (1008K) SPRAYED	2	
949-282911-12	HANDLE PANEL - SILVER (1008K) SPRAYED	2	
969-282902-00	LIGH GUIDING POST(TRANSPARENT)	1	
980-282901-13	SIDE JACK BASE- SILVER (1008K) SPRAYED	1	
991-282901-13	POWER KNOB - SILVER (1008K) SPRAYED	1	
1802829T23702	MAIN PCB		
002-129090-10	29" CRT A68EEH038X890 (S-FLAT) {WORLD-WIDE} "VID	1	#
008-900291-04	DEGAUSSING COIL 90T (W/FIVE LA YERS OF TAPE) FO	1	# L903
171-550084-B0	7" SAA APP LINE CORD 2-PIN PLUG	0	#
171-550084-D0	84" AC LINE CORD W/SAA APP. 10A 250V	1	#
171-550084-D1	7' SAA APP. LINE CORD W/PLUG E-CUTTING 45MM,15M	0	#
012-102340-0B	SEMI-FIXED RES. WI06-2AL-1K "SHENZHEN YUNGJIAN	1	VR901
101-160984-94	STANDBY SWITCHING TRANSFORMER KB16E984 "HIG	1	T970
101-191009-96	HORIZONTAL DRIVE TRANSFORMER (R1009)	1	T401
102-370600-0B	TANK COIL / AFC COIL 707851 "DONGGUAN LIHANG"	1	T101
105-100103-16	FIXED INDUCTIVE COIL 10UH 10% AL0305-100K "BOLU	6	L101-103,105,109,110
105-180103-08	FIXED INDUCTIVE COIL 18 UH +-10% 0410 "WITTIS"	1	L106
105-201106-02	CHOKE COIL 200UH 10% CH9012- 201K (ELEC PRODU	3	L403,904,W255
105-250102-35	LINEARITY COIL 25UH LX142242A HIGHLIGHT	1	L401
105-689103-16	FIXED INDUCTIVE COIL 6.8UH 10% AL0305-6R8K "BOL	1	L104
105-821156-06	CHOKE COIL 820UH 0.37 OHM HIGHLIGHT	1	L402
106-210048-01	RELAY 48V VS48MB "TAKAMISAWA"	1	RLY902
107-105500-66	SOUND TRAP CERAMIC FILTER 5.5MHZ WEI HAW	1	CF101
113-100105-17	CARBON FILM RESISTOR 10 OHM 1/4W +-5%	2	R238,242

PART_NO	DESCRIPTION	QTY	LOCATION
113-100505-75	METAL OXIDE FILM RESISTOR 10 OHM 3W +-5%	1	R422
113-101005-17	CARBON FILM RESISTOR 100 OHM 1/16W +-5%	7	R123,141,173,174,180,194,196 R201,202,207,236,237,239,240
113-101005-17	CARBON FILM RESISTOR 100 OHM 1/16W +-5%	10	,247,252,253
113-101005-17	CARBON FILM RESISTOR 100 OHM 1/16W +-5%	4	R501,502,503,160
113-101005-17	CARBON FILM RESISTOR 100 OHM 1/16W +-5%	20	R06-23,38,39
113-101305-75	METAL OXIDE FILM RESISTOR 100 OHM 1W +-5%	1	R939
113-102005-17	CARBON FILM RESISTOR 1K OHM 1/16W +-5%	12	R101,140,148,152,161,166,197 ,198,208,209,210,211
113-102005-17	CARBON FILM RESISTOR 1K OHM 1/16W +-5%	7	R245,249,250,267,268,402,510
113-102005-17	CARBON FILM RESISTOR 1K OHM 1/16W +-5%	4	R139,243,244,278
113-102105-17	CARBON FILM RESISTOR 1K OHM 1/4W +-5%	1	R973
113-102205-12	CARBON FILM RESISTOR 1K OHM 1/2W +-5%	3	R505-507
113-102305-75	METAL OXIDE FILM RESISTOR 1K OHM 1W +-5%	1	R410
113-103005-17	CARBON FILM RESISTOR 10K OHM 1/16W +-5%	6	R113,121,182,187,189,251
113-103005-17	CARBON FILM RESISTOR 10K OHM 1/16W +-5%	2	R05,185
113-103105-17	CARBON FILM RESISTOR 10K OHM 1/4W +-5%	1	R905
113-104005-17	CARBON FILM RESISTOR 100K OHM 1/16W +-5%	2	R142,413
113-104305-75	METAL OXIDE FILM RESISTOR 100K OHM 1W +-5%	1	R918
113-109105-17	CARBON FILM RESISTOR 1 OHM 1/4W +-5%	1	R235
113-109205-12	CARBON FILM RESISTOR 1 OHM 1/2W +-5%	3	R406-408
113-120305-75	METAL OXIDE FILM RESISTOR 12 OHM 1W +-5%	1	R909
113-120405-75	METAL OXIDE FILM RESISTOR 12 OHM 2W +-5%	1	R917
113-120505-75	METAL OXIDE FILM RESISTOR 12 OHM 3W +-5%	1	R423
113-121005-17	CARBON FILM RESISTOR 120 OHM 1/16W +-5%	1	R153
113-122005-17	CARBON FILM RESISTOR 1.2K OHM 1/16W +-5%	2	R269,285
113-122105-17	CARBON FILM RESISTOR 1.2K OHM 1/4W +-5%	1	R976
113-123005-17	CARBON FILM RESISTOR 12K OHM 1/16W +-5%	3	R114,203,206
113-123105-17	CARBON FILM RESISTOR 12K OHM 1/4W +-5%	1	R974
113-124005-17	CARBON FILM RESISTOR 120K OHM 1/16W +-5%	1	R127
113-129105-17	CARBON FILM RESISTOR 1.2 OHM 1/4W +-5%	1	R248
113-151205-12	CARBON FILM RESISTOR 150 OHM 1/2W +-5%	1	R936
113-152005-17	CARBON FILM RESISTOR 1.5K OHM 1/16W +-5%	2	R171,405
113-152205-12	CARBON FILM RESISTOR 1K5 OHM 1/2W +-5%	2	R508,429
113-153005-17	CARBON FILM RESISTOR 15K OHM 1/16W +-5%	2	R134,401
113-153405-75	METAL OXIDE FILM RESISTOR 15K OHM 2W +-5%	3	R418,970,971
113-158405-75	METAL OXIDE FILM RESISTOR 0.15 OHM 2W +-5%	1	R912
113-159905-51	WIRE WOUND CEMENT RESISTOR 1.5 OHM 10W +-5%	1	R924
113-181005-17	CARBON FILM RESISTOR 180 OHM 1/16W +-5%	1	R150
113-182105-17	CARBON FILM RESISTOR 1.8K OHM 1/4W +-5%	1	R904
113-220205-12	CARBON FILM RESISTOR 22 OHM 1/2W +-5%	1	R417
113-220505-75	METAL OXIDE FILM RESISTOR 22 OHM 3W +-5%	1	R428
113-221005-17	CARBON FILM RESISTOR 220 OHM 1/16W +-5%	3	R179,W151,152
113-222005-17	CARBON FILM RESISTOR 2.2K OHM 1/16W +-5%	2	R419,186
113-223005-17	CARBON FILM RESISTOR 22K OHM 1/16W +-5%	9	R103-105,107-112,420,
113-223105-17	CARBON FILM RESISTOR 22K OHM 1/4W +-5%	1	R972
113-224005-17	CARBON FILM RESISTOR 220K OHM 1/16W +-5%	1	R102
113-229505-75	METAL OXIDE FILM RESISTOR 2.2 OHM 3W +-5%	1	R509
113-229605-51	WIRE WOUND CEMENT RESISTOR 2.2 OHM 5W +-5%	1	R944

PART_NO	DESCRIPTION	QTY	LOCATION
113-243105-17	CARBON FILM RESISTOR 24K OHM 1/4W +-5%	1	R979
113-270405-75	METAL OXIDE FILM RESISTOR 27 OHM 2W +-5%	2	R910,01
113-270505-75	METAL OXIDE FILM RESISTOR 27 OHM 3W +-5%	1	R980
113-271005-17	CARBON FILM RESISTOR 270 OHM 1/16 W +-5%	2	R241,414
113-272005-17	CARBON FILM RESISTOR 2.7K OHM 1/16W +-5%	1	R126
113-272205-12	CARBON FILM RESISTOR 2.7K OHM 1/2W +-5%	1	R415
113-273005-17	CARBON FILM RESISTOR 27K OHM 1/16W +-5%	3	R119,258,135
113-331005-17	CARBON FILM RESISTOR 330 OHM 1/16W +-5%	8	R156,157,271,261-263,155
113-331105-17	CARBON FILM RESISTOR 330 OHM 1/4W +-5%	2	R901,938
113-332005-17	CARBON FILM RESISTOR 3.3K OHM 1/16W +-5%	7	R129-131,136,204,205,403
113-332102-17	CARBON FILM RESISTOR 3.3K OHM 1/4W +-2%	1	R907
113-332905-58	WIRE WOUND CEMENT RESISTOR 3K3 OHM 10W +-5%	1	R416
113-333005-17	CARBON FILM RESISTOR 33K OHM 1/16W +-5%	2	R183,184
113-334105-17	CARBON FILM RESISTOR 330K OHM 1/4W +-5%	1	R981
113-334305-75	METAL OXIDE FILM RESISTOR 330K OHM 1W +-5%	1	R911
113-335105-17	CARBON FILM RESISTOR 3.3M OHM 1/4W +-5%	1	R977
113-339105-17	CARBON FILM RESISTOR 3.3 OHM 1/4W +- 5%	1	R978
113-339405-75	METAL OXIDE FILM RESISTOR 3.3 OHM 2W +-5%	1	R411
113-390605-75	METAL OXIDE FILM RESISTOR 39 OHM 5W +-5%	1	R913
113-391005-17	CARBON FILM RESISTOR 390 OHM 1/16W +-5%	1	R147
113-392005-17	CARBON FILM RESISTOR 3.9K OHM 1/16W +-5%	2	R115,128
113-393005-17	CARBON FILM RESISTOR 39K OHM 1/16W +-5%	2	R143,190
113-470005-17	CARBON FILM RESISTOR 47 OHM 1/16W +-5%	2	W128,R149
113-470205-12	CARBON FILM RESISTOR 47 OHM 1/2W +-5%	1	R504
113-471005-17	CARBON FILM RESISTOR 470 OHM 1/16W +-5%	4	R412,163,164,165
113-471305-75	METAL OXIDE FILM RESISTOR 470 OHM 1W +-5%	1	R404
			R132,133,176,177,178,192,193
113-472005-17	CARBON FILM RESISTOR 4.7K OHM 1/16W +-5%	9	,200,199
113-472005-17	CARBON FILM RESISTOR 4.7K OHM 1/16W +-5%	4	R226,228,256,257
113-472005-17	CARBON FILM RESISTOR 4.7K OHM 1/16W +-5%	6	R265,266,02,03,254,255
113-472105-17	CARBON FILM RESISTOR 4.7K OHM 1/4W +-5%	1	R908
113-473005-17	CARBON FILM RESISTOR 47K OHM 1/16W +-5%	9	R270,25,26,28,29,31,32,34,35
113-560005-17	CARBON FILM RESISTOR 56 OHM 1/16W +-5%	1	R151
113-563005-17	CARBON FILM RESISTOR 56K OHM 1/16W +-5%	1	R234
113-680405-75	METAL OXIDE RESISTOR 68 OHM 2W +-5%	1	R122
113-681005-17	CARBON FILM RESISTOR 680 OHM 1/16W +-5%	1	R116
113-682005-17	CARBON FILM RESISTOR 6.8K OHM 1/16W +-5%	1	R124
113-682102-17	CARBON FILM RESISTOR 6.8K OHM 1/4W +-2%	1	R902
113-682105-17	CARBON FILM RESISTOR 6.8K OHM 1/4W +-5%	1	R906
113-683005-17	CARBON FILM RESISTOR 68K OHM 1/16W +-5%	1	R117
113-684005-17	CARBON FILM RESISTOR 680K OHM 1/16W +-5%	1	R409
113-688405-42	FUSEBLE RESISTOR 0.68 2W +-5%	2	R914,937
			R167-
113-750005-17	CARBON FILM RESISTOR 75 OHM 1/16W +-5%	10	169,24,27,30,33,36,37,172
113-820105-17	CARBON FILM RESISTOR 82 OHM 1/4W +-5%	1	R975
113-821005-17	CARBON FILM RESISTOR 820 OHM 1/16W +-5%	1	R195
113-822005-17	CARBON FILM RESISTOR 8.2K OHM 1/16W +-5%	1	R125
113-822105-17	CARBON FILM RESISTOR 8.2K OHM 1/4W +-5%	1	R903
113-823005-17	CARBON FILM RESISTOR 82K OHM 1/16W +-5%	1	R120
113-824005-17	CARBON FILM RESISTOR 820K OHM 1/16W +-5%	1	R118

PART_NO	DESCRIPTION	QTY	LOCATION
113-829105-17	CARBON FILM RESISTOR 8.2 OHM 1/4W +-5%	2	R259,260
123-101350-60	CERAMIC CAP. 100 PF 50V +-10% (SL TYPE) "SMART G	4	C102,196-198
123-102350-90	CERAMIC CAP. 0.001 MFD 50V +-10% (B TYPE)	6	C101,117,120,125,149,417
123-102850-10	CERAMIC CAP. 0.001 MFD 2KV +-10% MATSUSHITA	1	C504
123-103370-90	CERAMIC CAP. 0.01 MFD 50V +80 -20%	11	C126,188,189,405,06,18,19,27, 28,29,30 C139,141,151-
123-104270-90	CERAMIC CAP. 0.1 MFD 25V +80 -20%	8	153,202,205,225
123-104270-90	CERAMIC CAP. 0.1 MFD 25V +80 -20%	5	C232,432,145,236,146
123-122550-95	CERAMIC CAP. 1200PF 500V +-10% "YINAN DON'S"	1	C418
123-150340-93	CERAMIC CAP. 15 PF 50V +-5% (NPO)	3	C160,161,138
123-151350-60	CERAMIC CAP 150 PF 50V +-10% (SL TYPE)	1	C204
123-152850-10	CERAMIC CAP. 0.0015 MFD 2KV +-10% MATSUSHITA	1	C434
123-180340-93	CERAMIC CAP. 18 PF 50V +-5% (NPO)	1	C137
123-220340-60	CERAMIC CAP. 22 PF 50V +-5% (SL TYPE)	2	C203,206
123-220340-93	CERAMIC CAP. 22 PF 50V +-5% (NPO)	2	C164,165
123-222350-90	CERAMIC CAP. 0.0022 MFD 50V +-10% (B TYPE)	5	C119,124,133,144,168
123-222850-10	CERAMIC CAP. 0.0022 MFD 2KV +-10% MATSUSHITA	1	C912
123-223370-90	CERAMIC CAP. 0.022 MFD 50V +80 -20%	8	C121,147,159,163,221,229,02, 974
123-270340-60	CERAMIC CAP. 27 PF 50V +-5% (SL-TYPE)	4	C171-173,226
123-271350-60	CERAMIC CAP. 270 PF 50V +-10% (SL TYPE)	1	C123
123-272850-10	CERAMIC CAP. 0.0027 2KV	2	C503,914
123-360340-93	CERAMIC CAP. 36 PF 50V +-5% (NPO)	2	C406,407
123-470340-93	CERAMIC CAP. 47 PF 50V +-5% (NPO)	1	C170
123-471350-60	CERAMIC CAP. 470 PF 50V +-10% (SL TYPE)	6	C183-186,191,192
123-472550-90	CERAMIC CAP. 0.0047 MFD 500V +-10% (B TYPE)	1	C501
123-472552-90	CERAMIC CAP. 0.0047 MFD 500V +-10% (B TYPE) SMA	5	C904,903,906,928,929
123-472552-95	CERAMIC CAP. 0.0047 MFD 500V +-10% (B TYPE) "YINA	3	C424-426
123-820340-60	CERAMIC CAP. 82 PF 50V +-5% (SL TYPE)	1	C154
123-821850-10	CERAMIC CAP. 820 PF 2KV +-10% (SL TYPE) MATSUSH	1	C913
126-102071-01	MYLAR CAP. 0.001 MFD 50V +-10%	1	C401
126-103071-01	MYLAR CAP. 0.01 MFD 50V +-10%	3	C210,211,412 C135,217,402,411,429,911,112
126-104060-21	METALIZED POLYESTER FILM CAP. 0.1 MFD 63V +-5%	9	,208,209
126-104101-35	POLYPROPYLENE CAP. 0.1 MFD 100V +-10% "XIAMEN	1	C122
126-153071-01	MYLAR CAP. 0.015 MFD 50V +-10%	1	C973
126-153405-35	POLYPROPYLENE CAP. 0.015 MFD 400V +-5% "XIAMEN	1	C409
126-154071-01	MYLAR CAP. 0.15 MFD 50V +-10%	1	C131
126-223071-01	MYLAR CAP. 0.022 MFD 50V +-10%	3	C214,215,413
126-223401-35	POLYPROPYLENE CAP. 0.022 MFD 400V +-10% "XIAME	1	C416
126-332071-01	MYLAR CAP. 0.0033 MFD 50V +-10 %	3	C115,136,155
126-333071-01	MYLAR CAP. 0.033 MFD 50V +-10%	1	C907
126-334071-01	MYLAR CAP. 0.33 MFD 50V +-10%	2	W130,131
126-364211-31	POLYPROPYLENE CAP. 0.36 MFD 250V +-10%	1	C408
126-472071-01	MYLAR CAP. 0.0047 MFD 50V +-10%	3	C128,130,150
126-472201-41	METALLIZED POLYPROPYLENE CAP. 0.0047 MFD 2000	2	C414,415
126-473071-01	MYLAR CAP. 0.047 MFD 50V +-10%	1	C148
126-473201-35	POLYPROPYLENE CAP. 0.047 MFD 200V +-10% "XIAME	1	C419

PART_NO	DESCRIPTION	QTY	LOCATION
			C104-
			106,182,195,207,187,04,05,07-
126-474060-25	METALIZED POLYESTER FILM CAP. 0.47 MFD 63V +-5%	23	17,20,23,21
			C107-
			109,129,157,200,227,421,230,
127-105072-06	ELECT CAP. 1 MFD 50V +-20% {TAPING TYPE}	10	166
			C140,142,156,158,162,169,233
127-106042-06	ELECT CAP. 10 MFD 16V +-20% {TAPING TYPE}	8	,03
127-106072-03	ELECT. CAP. 10 MFD 50V +-20%	1	C116
127-106104-03	ELECT CAP. 10 MFD 100V +-20% 105°C	1	C908
127-106252-08	ELECT CAP. 10 MFD 250V +-20% "JAMICON"	1	C502
127-106402-0H	ELECT CAP. 10 MFD 400V +-20% "SHENZHEN JINGUAN"	1	C971
			C111,118,132,134,190,193,194
127-107042-03	ELECT. CAP. 100 MFD 16V +-20%	8	,431
127-107062-08	ELECT CAP. 100 MFD 35V +-20% "JAMICON"	1	C213
127-107132-07	ELECT. CAP. 100 MFD 160V +-20% "NICHICON"	2	C420,926
127-108052-03	ELECT. CAP. 1000 MFD 25V +-20%	2	C430,927
127-225072-06	ELECT CAP. 2.2 MFD 50V +-20% {TAPING TYPE}	5	C114,143,212,223,224
127-226042-06	ELECT CAP. 22 MFD 16V +-20% {TAPING TYPE}	1	C127
127-226252-08	ELECT CAP. 22 MFD 250V +-20% "JAMICON"	1	C433
127-227042-03	ELECT. CAP. 220 MFD 16V +-20%	6	C222,231,422,423,435,01
127-227052-06	ELECT CAP. 220 MFD 25V +-20% {TAPING TYPE}	1	C975
127-227062-08	ELECT CAP. 220 MFD 35V +-20% "JAMICON"	2	C403,427
127-227422-07	ELECT CAP. 220 MFD 420V +-20% "NICHICON"	1	C905
127-228052-03	ELECT. CAP. 2200 MFD 25V +-20%	1	C216
127-228052-0D	ELECT CAP. 2200 MFD 25V +-20% "NAM TUNG"	1	C930
127-475072-06	ELECT CAP. 4.7 MFD 50V +-20% {TAPING TYPE}	2	C404,428
127-475102-26	ELECT CAP. BIPOLAR 4.7 MFD 100V +-20% {TAPING TY	1	C410
127-475132-03	ELECT CAP 4.7 MFD 160V +-20%	1	C972
127-476042-03	ELECT. CAP. 47 MFD 16V +-20%	3	C110,220,228
127-476094-03	ELECT CAP. 47 MFD 63V +-20% 105°C	1	C910
127-477052-03	ELECT. CAP. 470 MFD 25V +-20%	2	C218,219
130-134004-00	RECTIFIER DIODE IN4004	4	D971,972,973,974
130-134148-01	SILICON DIODE IN4148	14	D101-111,114-116
130-240809-50	VERIABLE CAPACITANCE DIODE BB809	2	D112-113
130-310021-00	RECTIFIER DIODE EGIZ SANKEN	3	D970,975,976
130-310228-50	DAMPER DIODE BY228 "PHILIPS"	1	D402
130-310345-00	RECTIFIER DIODE 3JH45 TOSHIBA 3.0A 600V	2	D401,906
130-310406-00	BRIDGE RECTIFIER RBV-406 SANKEN	1	BR901
130-314002-00	RECTIFIER DIODE 1N4002 100V/1A	3	D501-503
			D403-
130-315295-00	RECTIFIER DIODE S5295G TOSHIBA	10	407,901,905,909,910,902
130-410036-00	ZENER DIODE 3.6V 1/2W	1	ZD103
130-410039-01	ZENER DIODE 3.9V	1	ZD901
130-410056-01	ZENER DIODE 5.6V	1	ZD902
130-410082-01	ZENER DIODE 8.2V	2	ZD102,903
130-410574-00	ZENER DIODE UPC 574J NEC	1	ZD401
130-411091-01	ZENER DIODE 9.1V	3	ZD403,904,01
130-610605-00	LED 3MM ROUND (RED/GREEN) BT605 "FOSHAN"	1	LED601
131-211015-00	TRANSISTOR 2SA1015 TOSHIBA	7	Q102-105,110,111,113
131-220774-20	TRANSISTOR 2SB774/Q/R/S MATSUSHITA	1	Q911

PART_NO	DESCRIPTION	QTY	LOCATION
131-220940-16	TRANSISTOR 2SB940P	1	Q401 Q106,108,109,910,912,117,11
131-231815-0A	TRANSISTOR 2SC1815 TOSHIBA	7	9
131-232335-30	TRANSISTOR 2SC2335 L/K NEC	1	Q970
131-232482-0A	TRANSISTOR 2SC2482 TOSHIBA	1	Q402
131-233619-00	TRANSISTOR 2SC3619	1	Q404
131-234706-00	TRANSISTOR 2SC4706 SHIN HO	1	Q909
131-240400-00	TRANSISTOR 2SD400E/F SANYO	1	Q913
131-241761-00	TRANSISTOR 2SD1761(E) ROHM	1	Q405
131-242500-00	TRANSISTOR 2SD2500 TOSHIBA	1	Q403
131-462369-0A	TRANSISTOR PH2369 PHILIPS	1	Q101
133-101219-14	I.C. TA1219AN I2C AV SELECTOR "TOSHIBA"	1	IC01
133-101501-33	I.C. TEA1501 PHILIPS	1	IC970
133-103722-12	I.C. M37221EASP MITSUBISHI (O.T.P.)	1	IC102
133-103857-33	IC TDA3857 PHILIPS	1	IC109
133-108354-33	I.C. TDA8354Q/N1 PHILIPS	1	IC401
133-108598-33	I.C. PCF8598C-2 PHILIPS	1	IC103
133-109870-33	I.C. TDA9870A DIGITAL TV SOUND PROCESSOR (DTVS	1	IC107
133-116107-33	I.C. TDA6107Q/N2 (IMPROVEMENT) PHILIPS	1	IC501
133-202615-33	IC TDA2615 (PHILIPS)	1	IC108
133-304241-31	I.C. M74HCT241B1 SGS	1	IC104
133-507808-61	I.C. KA7808 SAMSUNG	1	IC402
133-517805-61	I.C. KA7805 SAMSUNG	2	IC403,404
136-500038-00	REMOTE CONTROL RECEIVER HS0038A2 "TEMIC"	1	OPT602
137-245760-30	CRYSTAL 24.576MHZ	1	X105
137-357954-20	CRYSTAL 3.579545 MHZ "KOWHA"	1	X102
137-443361-25	CRYSTAL 4.433619 MHZ 20PF "BAOTOU"	1	X101
137-800000-20	CRYSTAL 8.0 MHZ KITRONICS	1	X103 S104-107,608-610 (ON
146-104614-14	TACT SWITCH 31TM114C UNITRONIC	7	FUNCTION PCB)
160-101001-08	PIN CONNECTOR 1 PIN PLUG STRAIGHT	3	CN501,901,902
160-102254-27	WAFER 2 PINS S11-2W-R (ANGLE TYPE) S.H.S	1	CN02
160-102255-27	PIN CONNECTOR 2 PINS PLUG STRAIGHT (UL) (S.H.S)	3	CN107,108,111
160-102805-08	PIN CONNECTOR 2 PIN PLUG STRAIGHT	1	CN903
160-103255-27	PIN CONNECTOR 3 PINS PLUG	4	CN103,105,106,110
160-103805-08	PIN CONNECTOR 3 PIN PLUG STRAIGHT	2	CN403,402
160-104254-27	PIN CONNECTOR 4 PINS PLUG (ANGLE TYPE)	1	J903
160-104255-27	PIN CONNECTOR 4 PINS PLUG (SHS)	3	CN113,404,115
160-104805-08	PIN CONNECTOR 4 PIN PLUG STRAIGHT	1	CN401
160-105255-27	PIN CONNECTOR 5 PINS WAFER 2.5 PITCH	3	CN101,104,114
160-108255-27	PIN CONNECTOR 8 PINS PLUG	2	J904,CN109
160-109254-27	PIN CONNECTOR 9 PINS PLUG (ANGLE TYPE)	1	CN01
160-109255-27	PIN CONNECTOR 9 PINS PLUG	1	CN112
161-301302-21	DIN SOCKET "CONIC"	1	J13 (J16 FOR SIDE AV IN &
161-470002-06	RCA JACK 2 PIN (BLACK) ANGLE AV-8.4-4B "LEQING C	1	EARPHONE BOARD) (J14 FOR SIDE AV IN &
161-470003-09	RCA JACK 2 PIN (YELLOW) ANGLE AV-8.4-6Y "LOQING	1	EARPHONE BOARD)
161-472003-04	RCA JACK 2 PIN YELLOW AV-8.4-2 "SHENZHEN LUNGG	2	J10,07
161-473202-01	RCA JACK 2 PIN AV-8.4-2 BLACK "SHENZHEN LONGGA	2	J08,11
161-473204-00	RCA JACK 3 PIN UIC-032-04AR RED "UNITRONIC"	2	J09,J12

PART_NO	DESCRIPTION	QTY	LOCATION
161-473204-09	RCA JACK 3 PIN RED RIGHT ANGLE "LOING CONIC"	1	(J15 FOR SIDE AV IN & EARPHONE BOARD)
161-481105-32	RF CONNECTOR UIC-0421-01-010A CHINA LANDMARK	1	FOR ANT INPUT
161-682102-22	21 PIN SCART SOCKET	1	J901
172-620005-40	UL 1007 TOP COAT WIRE AWG 20 50MM BLACK 5 X 5M	1	FOR SHIELD CAN TO TUNER FOR TUNER TO FLAT
172-620036-40	UL 1007 TOP COAT WIRE AWG 20 360MM BLACK 10 X	1	BRIDED WIRE CRT SOCKET PIN 12 TO
172-622007-40	UL 1007 TOP COAT WIRE #22 70MM BLACK 5 X 5 MM	1	CN501 GND FROM CN106 GND TO R257
172-626004-40	UL 1007 TOP COAT WIRE AWG26 40MM BLACK 5 X 5 M	1	GND Q909 LUG TO POWER PCB 'Z', Q403 LUG TO MAIN PCB
172-626008-40	UL 1007 TOP COAT WIRE AWG26 80MM BLACK 10 X 10	2	'K' W03-16,101-111,113-119,121-
172-726000-99	BARE WIRE 54MM	10.2	127,129,132-170,172 (W901-902 ON SCART PCB),R04,154,430,C26,W21,2
172-726000-99	BARE WIRE 54MM	0	2,23 W175-207,D195,W256-
172-726000-99	BARE WIRE 54MM	0	265,501-504,W287-289 R431,138,(W601 ON
172-726000-99	BARE WIRE 54MM	0	FUNCTION PCB) (W901,906,909,907 ON
172-726000-99	BARE WIRE 54MM	0	POWER P.C.B.) (Q604
172-726000-99	BARE WIRE 54MM	0	'B'TO'C',W681,R688,601,685, 684 ON SENSOR PCB
172-726000-99	BARE WIRE 54MM	0	W209,210,279,287,288,290,29
172-726000-99	BARE WIRE 54MM	0	1,292
172-726000-99	BARE WIRE 54MM	0	W211-235,237-247,252-254
172-830120-99	FLAT BRIDED WIRE	2.6	CRT GROUND
179-001010-00	OIL SLEEVING 1 mm DIA.	0.03	20MM FOR D906,10MM-C907
179-105000-00	UL PVC TUBE 5mm DIA	0.2	FOR CN901,902 700MM FOR LEFT
179-105000-00	UL PVC TUBE 5mm DIA	1.4	SPK.,700MM FOR RIGHT SPK. 220MM FOR DOUBLE
179-107300-00	UL PVC TUBE 7.3MM DIA.	0.22	INSOLATION WIRE
179-110500-00	UL PVC TUBE 11MM DIA.	0.05	50MM FOR AC LINE CORD
179-403030-00	3MM DIA. SHRINKABLE TUBE	0.07	70MM FOR AC LINE CORD
184-350805-08	AXIAL LEAD BEAD INDUCTORS "COILS"	5	FB101,102,401,402,901
190-282900-P7	SENSOR P.C.B (120799)REV1	1	
190-282909-06	FUNCTION P.C.B. (250100)	1	
190-829B03-08	21 PIN SOCKET P.C.B.(180999)	1	
190-88200A-XE	POWER SWITCH P.C.B. (131196)	1	
190-932900-00	CRT P.C.B.(191099)	1	
190-932908-07	POWER P.C.B. (111099)	1	
190-932912-P1	MAIN P.C.B. (07032000)	1	

PART_NO	DESCRIPTION	QTY	LOCATION
190-932913-P8	AV P.C.B.(210100)	1	
191-101007-10	1 PIN SOCKET ASS'Y L=350MM (DOUBLE INSULATION)	1	FOR CN501 TO CRT GND CN107 '1' TO RIGHT
191-201006-10	2 PIN SOCKET ASS'Y L=700MM	1	SPK. '+', '2' TO RIGHT '-' CN111 TO POWER BOARD
191-201234-10	2 PIN SOFT WIRE L=350MM(1 SIDE SOCKET,1 SIDE PL	1	PIN '1' TO '8', '2' TO '7'
191-201240-10	2 PIN L=340MM #26 UL1185 (W/SINGLE SHIELD WIRE)	1	CN108 TO CN02 CN106 '1' TO LEFT SPK. '+', '2' TO LEFT SPK. '-'
191-301005-02	3 PINS SOCKET ASS'Y (2 WIRE) L=560MM	1	CN403 TO POWER BOARD
191-301036-07	3 PIN SOCKET ASS'Y L=480MM	1	PIN '1' TO '4', '2' TO '5'
191-301036-07	3 PIN SOCKET ASS'Y L=480MM	0	'3' TO '6' CN402 TO POWER BOARD
191-301067-10	3 PIN L=350MM #22 UL1672 (2 WIRE) STV8-3H	1	PIN '2' TO '1', '3' TO '2' CN103 TO J905,CN105 TO CN04
191-301271-10	3 PIN FLAT CABLE L=500MM AWG26 UL2468 (SOFT WI	2	CN110 TO CN06
191-301272-10	3 PIN FLAT CABLE L=340MM AWG26 UL2468 (SOFT WI	1	CN404 TO CRT BOARD PIN '1' TO 'FF', '2' TO 'GND', '3' TO 'GND', '4' TO '180V' CN113 TO FUNCTION PCB
191-401025-10	4 PIN SOCKET ASS'Y L=450MM (FLAT CABLE) UL2468	1	
191-401025-10	4 PIN SOCKET ASS'Y L=450MM (FLAT CABLE) UL2468	0	'1' TO 'D', '2' TO 'C', '3' TO 'B' '4' TO 'A' CN115 TO FUNCTION PCB
191-401041-10	4 PIN FLAT CABLE L=250MM	2	
191-401041-10	4 PIN FLAT CABLE L=250MM	0	'1' TO 'E', '2' TO 'F', '3' TO 'G' '4' TO 'H'
191-401041-10	4 PIN FLAT CABLE L=250MM	0	
191-401232-10	4 PIN L=220MM AWG26 UL1185 W/ TRIPLE SHIELD WIR	1	CN07 TO J903 CN101 TO CRT BOARD PIN '1' TO 'E', '2' TO 'D', '3' TO 'C', '4' TO 'B', '5' TO 'A'
191-501033-10	5 PIN FLAT CABLE L=400MM AWG26 UL2468	1	
191-501033-10	5 PIN FLAT CABLE L=400MM AWG26 UL2468	0	
191-501228-10	5 PIN FLAT CABLE L=500MM AWG26 UL2468 (SOFT WI	1	CN104 TO CN03A CN05 TO SIDE AV BOARD PIN '1' TO 'A', '2' TO 'B' '3' TO 'C', '4' TO 'D', '5' TO 'E'
191-501229-10	5 P FLAT CABLE #26 UL2468 MALE 400MM,FEMALE 36	1	
191-501229-10	5 P FLAT CABLE #26 UL2468 MALE 400MM,FEMALE 36	0	
191-801225-10	8 PIN L=400MM #26 UL2468 (P1-4 ,6,7 FLAT CABLE,P5,8	1	CN109 TO J904
191-901214-10	9 PIN 340MM #26 UL2468 P1-3 FL AT CABLE,P4-5,6-7,8-	1	CM112 TO CN01 FOR TUNER TO RF CONNECTOR
402-522001-11	COAXIAL CABLE W/DIN, RCA 250MM W/3 SOLDERING	1	
504-305006-10	MACHINE SCREW 3 X 6 B/M (WHITE)	3	1-IC404, 1-IC108, 1-IC501
515-303406-10	SELF-TAPPING SCREW 3 X 6 W/B/T (HARDEN)	2	FOR 161-682102-22 6-AV IN/OUT PCB,2-IC401,1- IC402,1-IC403,1-Q403
515-303408-10	SELF-TAPPING SCREW 3 X 8 W/B/T (HARDEN)	13	
515-303408-10	SELF-TAPPING SCREW 3 X 8 W/B/T (HARDEN)	0	2-781-382501-00 TO 781- 382903-03
517-303312-10	SELF-TAPPING SCREW 3 X 12 W/A W/H=7MM (HARDE	2	1 FOR BR901,1 FOR Q909 4-L901,4-L905,2-T402,2- L401,2-R416,2-C408,1-Q403`C 2-L402
540-020030-01	EYELET 2 X 3 MM	19	
540-020030-01	EYELET 2 X 3 MM	0	
580-101004-04	TWIST LOCK SUPPORTS "KANGLI"	1	FOR CN403
580-101261-01	CABLE TIE L=100MM	15	

PART_NO	DESCRIPTION	QTY	LOCATION
580-101261-01	CABLE TIE L=100MM	3	
			FOR DEGAUSSING COIL
580-102261-00	CABLE TIE L=200MM W=3.5MM	2	MTG.
			FOR DEGAUSSING COIL
580-103261-00	CABLE TIE L=300MM W=3.5MM	6	MTG.
661-932501-01	FUSE LABEL - ATAKI DESIGN (T4A/250V)	1	
744-881301-00	SPRING FOR C.R.T. MOUNTING 5.2 X 42 X 0.6MM	2	
746-063101-01	AC LINE CORD PIN	4	FOR POWER SWITCH PCB
750-063101-00	SOLDERING LUG LEG:8X4MM	2	FOR Q403,Q909
			FOR AC LINE
750-063102-01	35MM SOLDERING LUG OD:7 ID:3.2 LEG:4X35MM	6	CORD,SPK.,CONNECTOR
766-686801-00	FUSE HOLDER	2	F901
779-882001-01	IRON HEAT SINK (D)	1	FOR IC404
779-882803-01	IRON HEAT SINK	2	FOR IC108,501
781-382501-00	ALUMINIUM HEAT SINK	1	FOR 781-382903-03
781-382903-03	ALUMINUM HEAT SINK	1	FOR IC401,402,403,Q403
781-932501-03	ALUMINIUM HEAT SINK (POWER)	1	FOR Q909,BR901
783-931304-02	SHIELD CAN	1	
783-931305-06	SHIELD CAN COVER "NEW"	1	FOR 783-931304-03
929-282903-00	LED BRACKET	1	
929-821C01-00	REMOTE BRACKET	1	FOR 130-600038-00
980-729A12-U0	JAKC PLATE W/BRASS INSERL UL 940V	1	
001-234234-10	FLYBACK TRANSFORMER JF0101-0134A SHEKOU JEW	1	# T402
101-288270-95	LINE FILTER LB28T270	2	# L901,905
101-288280-95	LINE FILTER 50MH FOR 28"	0	# L901,905
113-565210-99	CARBON COMPOSITION RESISTOR 5.6M OHM 1/2W +-	2	# R948,921
113-688305-42	FUSING RESISTOR 0.68 OHM 1W +-5%	2	# R421,915
113-688305-49	FUSING RESISTOR 0.68 OHM 1W +-5% "KOA"	0	# R421,915
114-210262-00	THERMISTOR PTH451C262B	0	# TH901
114-210270-02	THERMISTOR 18 OHM 270V #2322 662 96524 "PHILIPS"	0	# TH901
114-210270-12	THERMISTOR 18 OHM 276V #2322 662 96724 "PHILIPS"	1	# TH901
114-210290-00	THERMISTOR 18 OHM +-20% #PTH451C234BG180M290	0	# TH901
123-222466-47	CERAMIC CAP. 0.0022 MFD 400VAC +-20% W/IEC384-1	0	# C917
123-222466-50	CERAMIC CAP. 0.0022 MFD 400VAC +-20% ECKDNA22	1	# C917
123-222466-51	CERAMIC CAP. 0.0022 MFD 400V +-20% W/IEC 384-14 A	0	# C917
126-473222-41	METALIZED POLYPROPYLENE CAP. 0.047 MFD 275V +	2	# C980,970
126-473222-45	METALIZED POLY.CAP. 0.047 MFD 275VAC +-20% "XIA	0	# C980,970
126-474222-45	METALIZED POLY.CAP. 0.47 MFD 275VAC +-20% "XIAM	1	# C901
126-474222-45	METALIZED POLY.CAP. 0.47 MFD 275VAC +-20% "XIAM	0	# C901
146-100001-14	POWER SWITCH (ESB-99957S COST COST REDUCTIO	0	#
146-100006-14	POWER SWITCH PS5E-B "CHINA LANDMARK"	1	#
161-540004-01	CRT SOCKET ISH-01 IN CHANG	1	# SK501
182-224000-03	FUSE T4A 250V	1	# F901
182-224000-23	FUSE T4A/250V 5 X 20 MM TIME- LAG #50T040H "UNITR	0	# F901
182-224000-33	FUSE 4A/250V 5 X 20MM SLO-BLO #218004 LITTELFUS	0	# F901
			# FROM POWER SWITCH TO
191-101012-10	1 PIN DOUBLE INSOLATION WIRE AWG 18 L=400MM B	1	CN901 ON POWER PCB
			# FROM POWER SWITCH TO
191-101013-10	1 PIN DOUBLE INSOLATION WIRE AWG 18 L=400MM B	1	CN902 ON POWER PCB
101-493260-94	SWITCHING POWER TRANSFORMER KB493260 EC49	1	# T901
113-688405-42	FUSEBLE RESISTOR 0.68 2W +-5%	3	# R424,425,426

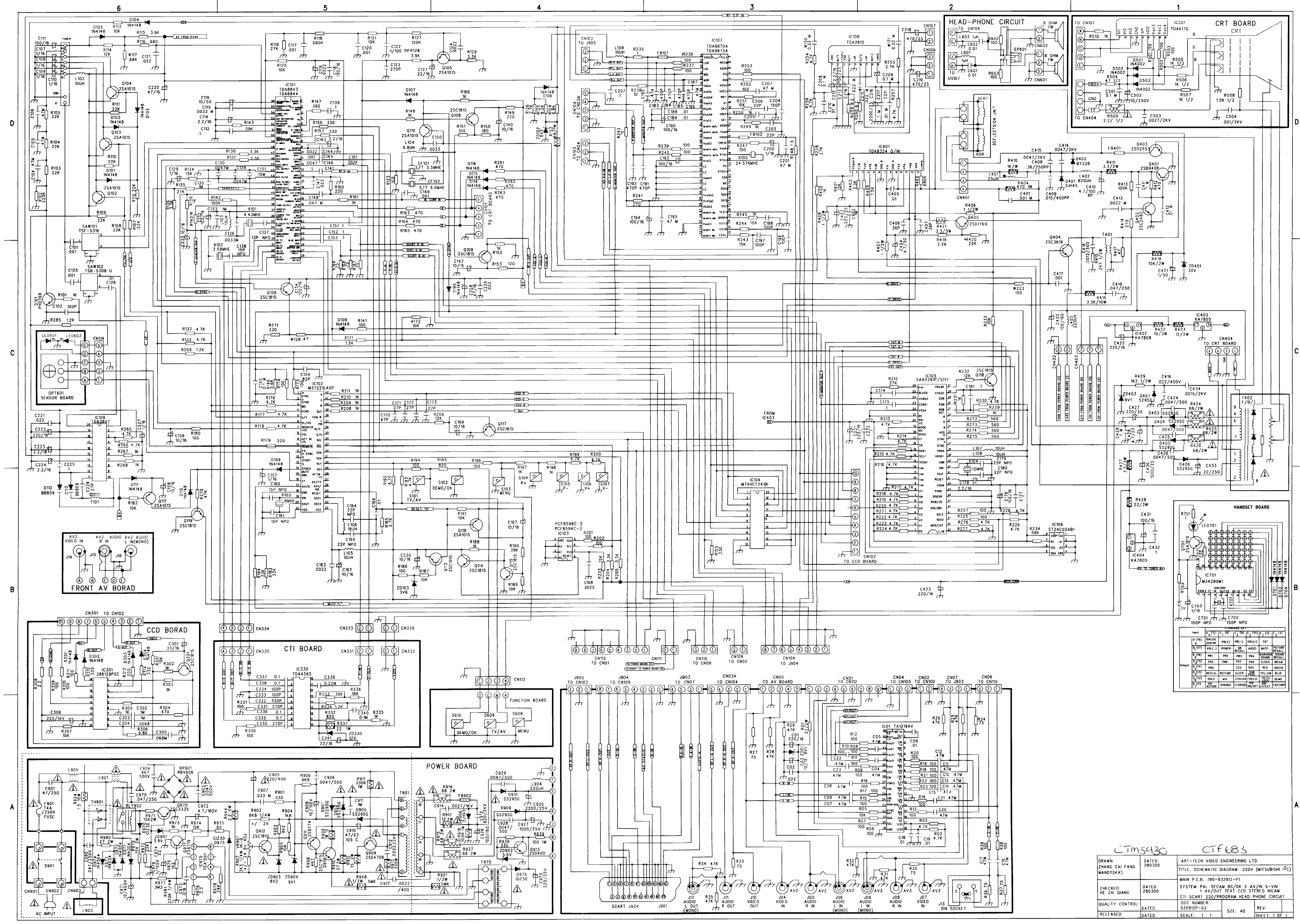

CTMS930 CTF683
 DRAWN: ZHANG CAI FANG MANDY(HK) DATED: 280300
 CHECKED: HE ZHI QIANG DATED: 280300
 QUALITY CONTROL: DATED: 83292P-03
 RELEASED: DATED: SCALE: 1:1 SIZE: A0 SHEET: 1 OF 1
 ART-TECH VIDEO ENGINEERING LTD.
 TITLE: SCHEMATIC DIAGRAM 220V (MITSUBISHI IC)
 MAIN P.C.B.: 190-932912-P1
 SYSTEM: PAL-SECAM BG/DK 3-AV-IN S-VIN
 1-AV/OUT TEXT CCD STEREO NICAM
 CT1 SCART 220/PROGRAM HEAD-PHONE CIRCUIT
 DOC NUMBER: 83292P-03 REV: